



# INSTALLATION INSTRUCTIONS DL60 CLOSED IC-RATED

## IMPORTANT

**Read carefully before installing fixture. Retain instructions for future reference.**

THIS PRODUCT MUST BE INSTALLED IN ACCORDANCE WITH THE APPLICABLE INSTALLATION CODE BY A PERSON FAMILIAR WITH THE CONSTRUCTION AND OPERATION OF THE PRODUCT AND THE HAZARDS INVOLVED. CONSULT A QUALIFIED ELECTRICIAN TO ENSURE CORRECT BRANCH CIRCUIT CONDUCTOR.

**WARNING: RISK OF FIRE OR ELECTRICAL SHOCK.**

**WARNING:** Make certain power is OFF before installing or maintaining fixture.

**WARNING:** Suitable for installation only in accessible ceilings. Access above the ceiling is required.

**WARNING:** SUITABLE FOR DRY OR DAMP LOCATIONS ONLY.

### STEP 1. INSTALL HOUSING

Install housing using supplied nailer bars. Bracket can be adjusted vertically by removing access panel and loosening wingnut until desired height is achieved. Butterfly brackets are also available for use with channel or 1/2" EMT.

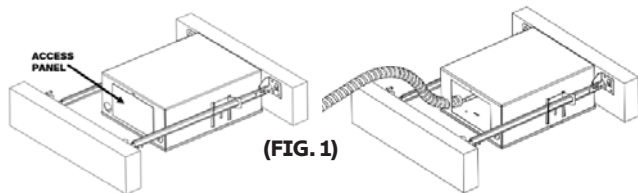

### STEP 2. RUN WIRES TO THE DL60 JUNCTION BOX

With access panel removed, insert flexible conduit into housing through knockout. Pull flexible conduit through aperture and attach fitting. Attach junction box to fitting using 1/2" knockout. Make internal wiring connections following wiring directions seen below. Place junction box into housing.

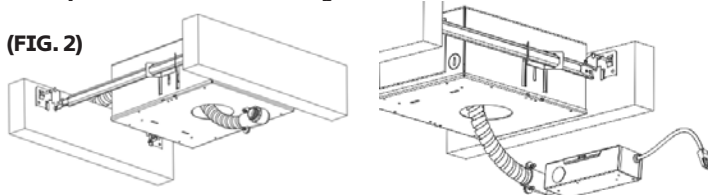

## WIRING

Note: Driver permits operation at 120V through 277V, 50Hz or 60Hz.

For non dimming and triac and electronic low voltage (ELV) dimming, follow wiring directions in Fig. 3.

1. Connect ground wire from fixture to supply ground.
2. Connect black fixture lead to (+) Line supply lead.
3. Connect white fixture lead to (-) Common supply lead.

For 0 - 10V dimming, follow wiring directions in Fig. 4.

(FIG. 3)

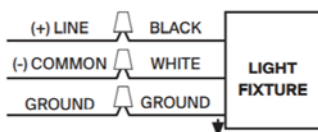

(FIG. 4)

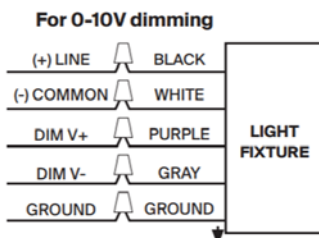

### STEP 3. INSTALL CEILING AND MARK APERTURE LOCATION

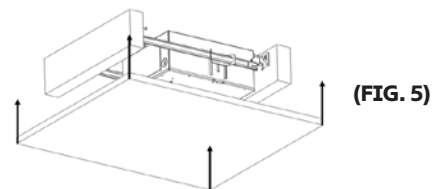

### STEP 4. MAKE CEILING CUTOUT. Rotary tool recommended.

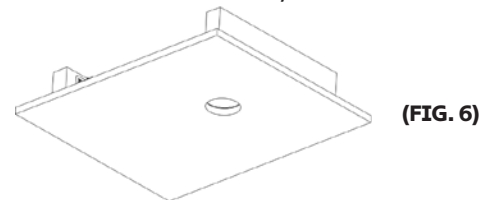

### STEP 5. CONNECT MODULE TO POWER SUPPLY

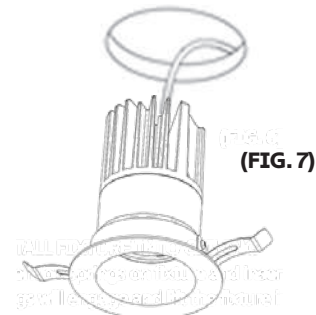

### STEP 6. INSTALL FIXTURE INTO CEILING

Bend springs inward and mount DL60 module onto the ceiling by pushing upwards.

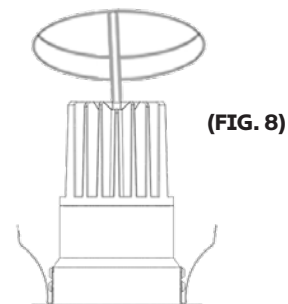



# INSTALLATION INSTRUCTIONS DL60, DLA60 & DL75 RETROFIT NON-IC

## IMPORTANT

**Read carefully before installing fixture. Retain instructions for future reference.**

THIS PRODUCT MUST BE INSTALLED IN ACCORDANCE WITH THE APPLICABLE INSTALLATION CODE BY A PERSON FAMILIAR WITH THE CONSTRUCTION AND OPERATION OF THE PRODUCT AND THE HAZARDS INVOLVED. THE POWER UNIT SHOULD BE INSTALLED WHERE IT WILL **NOT** BE SUBJECTED TO ANY MOVEMENT. CONSULT A QUALIFIED ELECTRICIAN TO ENSURE CORRECT BRANCH CIRCUIT CONDUCTOR.

**WARNING:** RISK OF FIRE OR ELECTRICAL SHOCK.

**WARNING:** Make certain power is OFF before installing or maintaining fixture.

**WARNING:** Suitable for installation only in accessible ceilings. Access above the ceiling is required.

**WARNING:** Do not install insulation within 3 in (76mm) of any part of the Luminaire.

**WARNING:** SUITABLE FOR DRY OR DAMP LOCATIONS ONLY.

### STEP 1. MAKE CEILING CUTOUT

Please refer to ceiling cutout dimensions below.

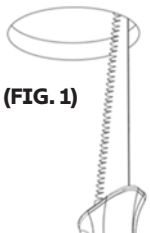

(FIG. 1)

Product	Ceiling Cutout
DL60	3"
DL60 Square	3" x 3"
DL75	3 3/8"

### STEP 2. RUN WIRES TO THE DL60 JUNCTION BOX

Pull the pre-existing wiring through the ceiling cutout and connect to the junction box using the 1/2" knockout. Lid screw must be removed to access internal wiring.

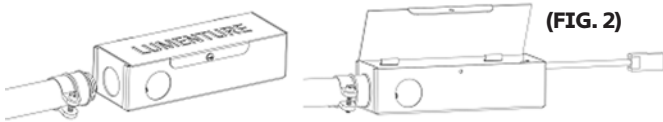

(FIG. 2)

## WIRING

Note: Driver permits operation at 120V through 277V, 50Hz or 60Hz.

For non dimming and triac and electronic low voltage (ELV) dimming, follow wiring directions in Fig. 4.

1. Connect Ground wire from fixture to supply ground.
  2. Connect black fixture lead to (+) Line supply lead.
  3. Connect white fixture lead to (-) Common supply lead.
- For 0 - 10V dimming, follow wiring directions in Fig. 5.

(FIG. 3)

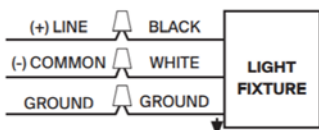

(FIG. 4)

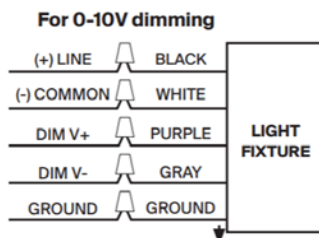

### STEP 3. CLOSE JUNCTION BOX, REPLACE SCREW AND INSERT JUNCTION BOX INTO CEILING CUTOUT

Leave junction box output wiring accessible from below the ceiling. NOTE: Ensure that installation complies with the local and national codes. If necessary, mount to nearby joist using self-tapping screw inside of the junction box away from wiring.

NOTE: Junction box to be installed where it will NOT be subjected to any movement.

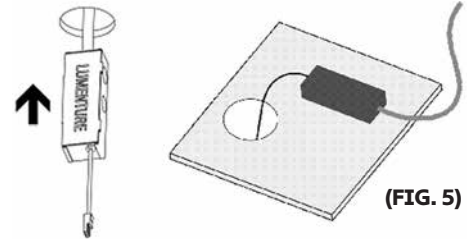

(FIG. 5)

### STEP 4. Connect fixture to junction box using the quick connects.

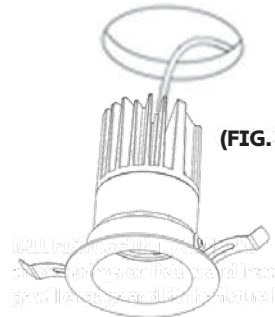

(FIG. 6)

### STEP 5. INSTALL FIXTURE INTO CEILING

Compress retention springs and insert DL60 into the ceiling cutout. Press trim firmly against the ceiling to fully engage springs.

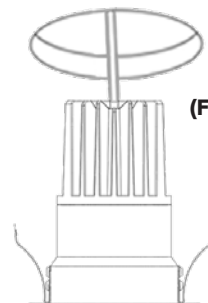

(FIG. 7)



# INSTALLATION INSTRUCTIONS DL60 FLANGELESS

## IMPORTANT

**Read carefully before installing fixture. Retain instructions for future reference.**

THIS PRODUCT MUST BE INSTALLED IN ACCORDANCE WITH THE APPLICABLE INSTALLATION CODE BY A PERSON FAMILIAR WITH THE CONSTRUCTION AND OPERATION OF THE PRODUCT AND THE HAZARDS INVOLVED. CONSULT A QUALIFIED ELECTRICIAN TO ENSURE CORRECT BRANCH CIRCUIT CONDUCTOR.

**WARNING: RISK OF FIRE OR ELECTRICAL SHOCK.**

**WARNING:** Make certain power is OFF before installing or maintaining fixture.

**WARNING:** Suitable for installation only in accessible ceilings. Access above the ceiling is required.

**WARNING:** Do not install insulation within 3 in (76mm) of any part of the Luminaire.

**WARNING:** SUITABLE FOR DRY OR DAMP LOCATIONS ONLY.

**STEP 1.** Cut a 3¼" hole in the ceiling.

**STEP 2.** Insert the module mud plate/retaining ring into the hole and secure it to the ceiling with four (4) No. 8 screws (by others).

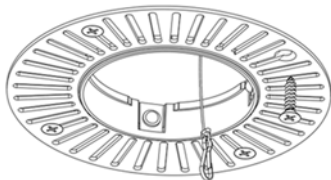

(FIG. 1)

**STEP 3.** Carefully plaster the ceiling around the mud plate.

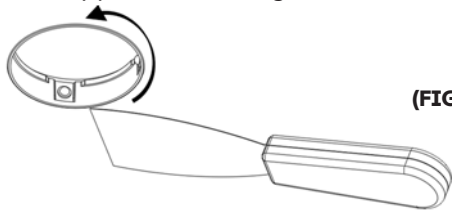

(FIG. 2)

**STEP 4.** RUN WIRES TO THE DL60 JUNCTION BOX

Pull the pre-existing wiring through the ceiling cutout and connect to the junction box using the ½" knockout. Lid screw must be removed to access internal wiring.

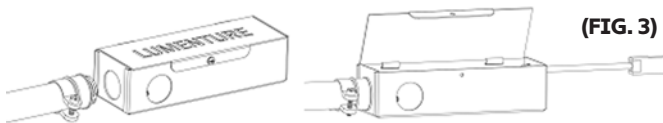

(FIG. 3)

## WIRING

Note: Driver permits operation at 120V through 277V, 50Hz or 60Hz. For non dimming and triac and electronic low voltage (ELV) dimming, follow wiring directions in Fig. 4.

1. Connect Ground wire from fixture to supply ground.
  2. Connect black fixture lead to (+) Line supply lead.
  3. Connect white fixture lead to (-) Common supply lead.
- For 0 - 10V dimming, follow wiring directions in Fig. 5.

(FIG. 3)

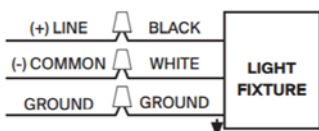

(FIG. 4)

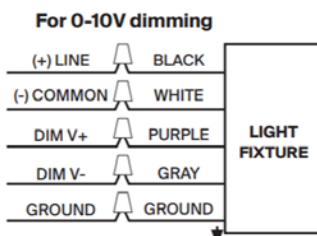

**STEP 5.** CLOSE JUNCTION BOX, REPLACE SCREW AND INSERT JUNCTION BOX INTO CEILING CUTOUT

Leave junction box output wiring accessible from below the ceiling. NOTE: Ensure that installation complies with the local and national codes. If necessary, mount to nearby joist using self-tapping screw inside of the junction box away from wiring.

NOTE: Junction box to be installed where it will NOT be subjected to any movement.

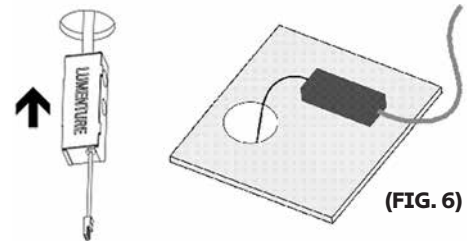

(FIG. 6)

**STEP 6.** Connect DL60 fixture to the junction box using the quick connects. Attach safety cable to the module.

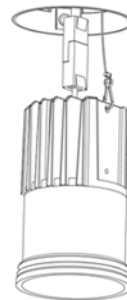

(FIG. 7)

**STEP 7.** INSTALL FIXTURE INTO CEILING

Insert module into the retaining ring, pushing up until the module clicks into place.

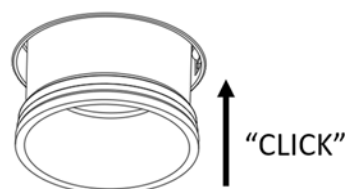

(FIG. 8)



Thank you for buying Lumenture Fixtures.  
We welcome your feedback: info@lumenture.com

www.lumenture.com  
20210210